

# Main Map

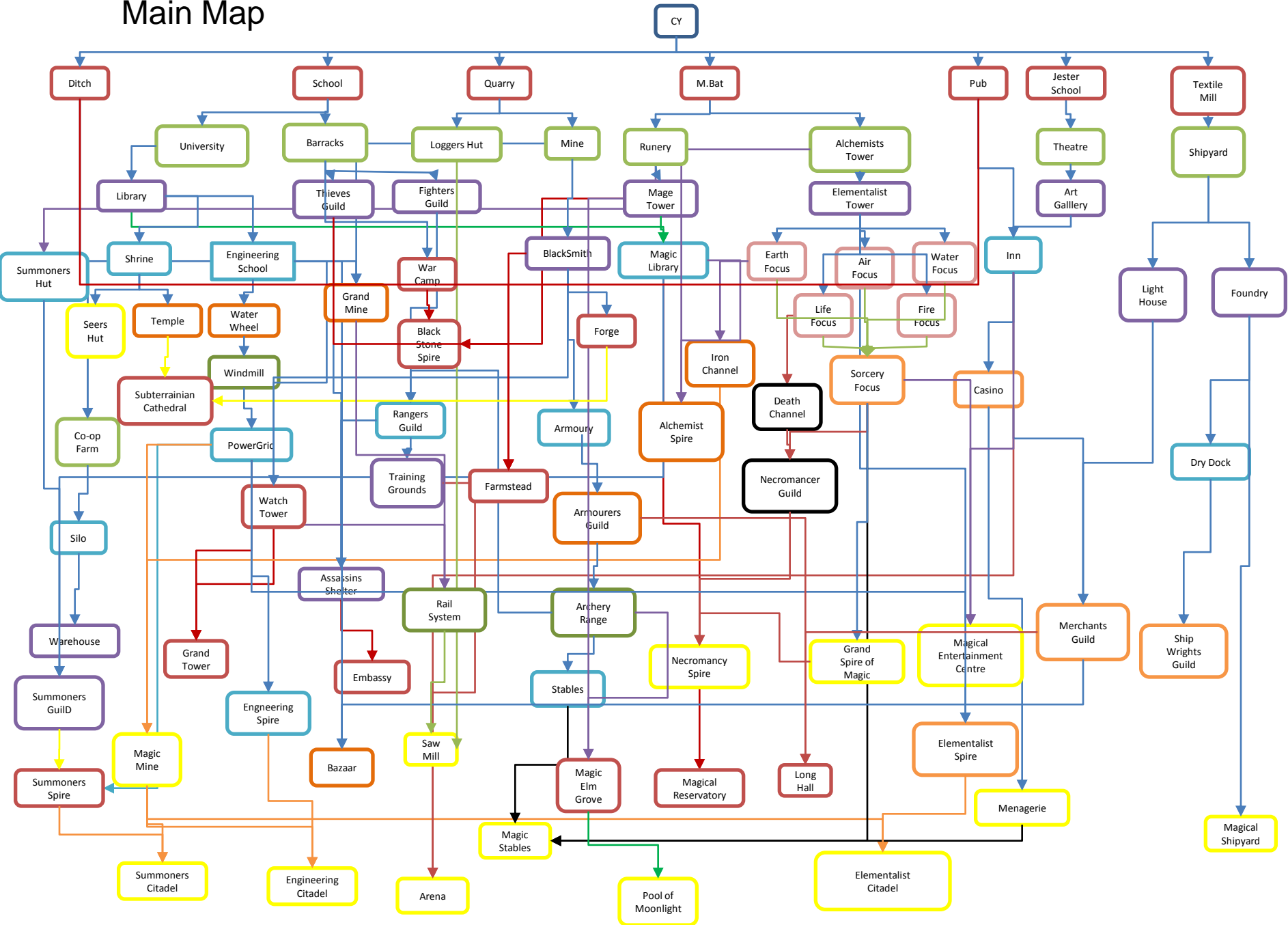

# Initial Construction Options

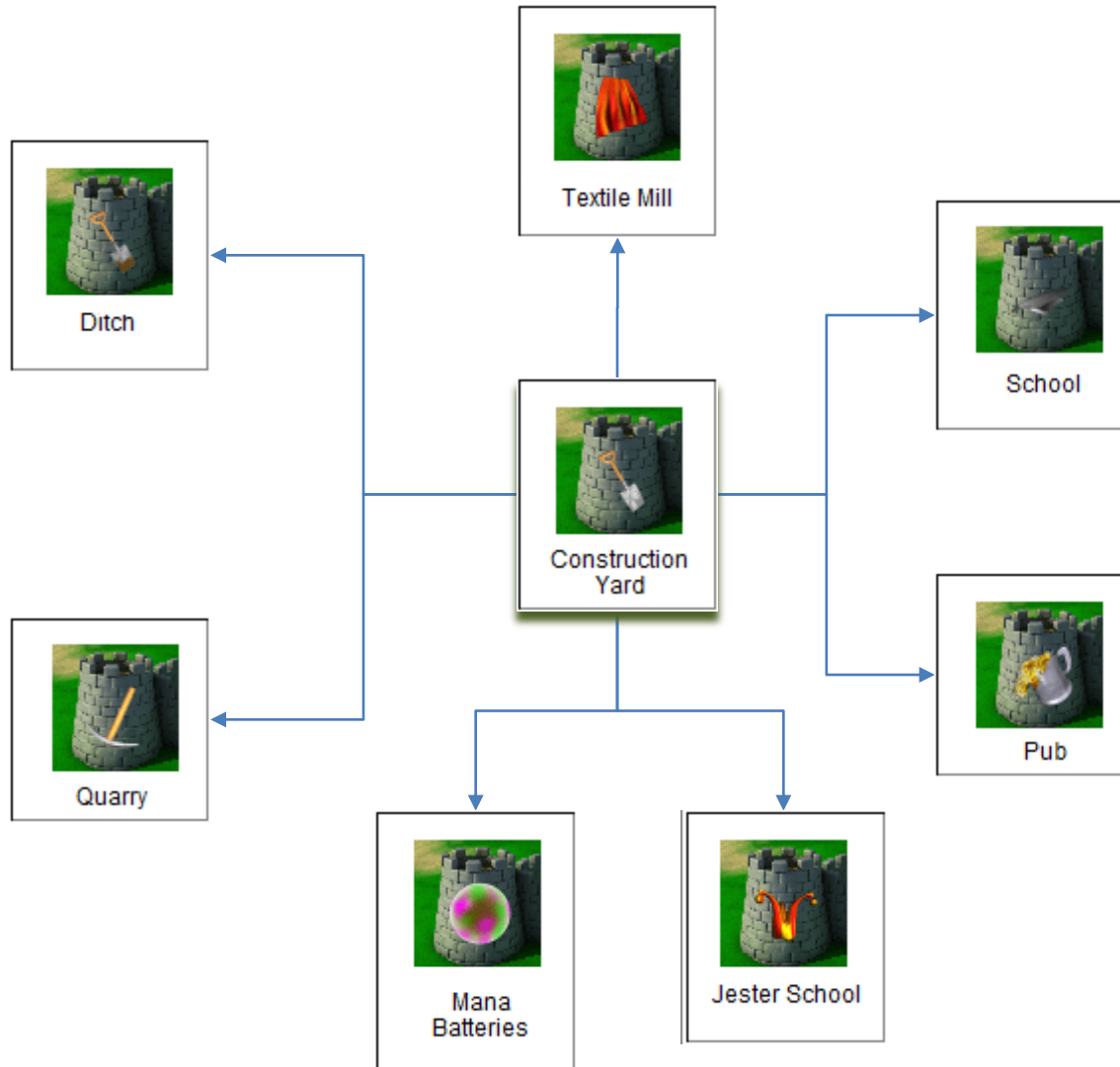

# Darkness / Undead Path

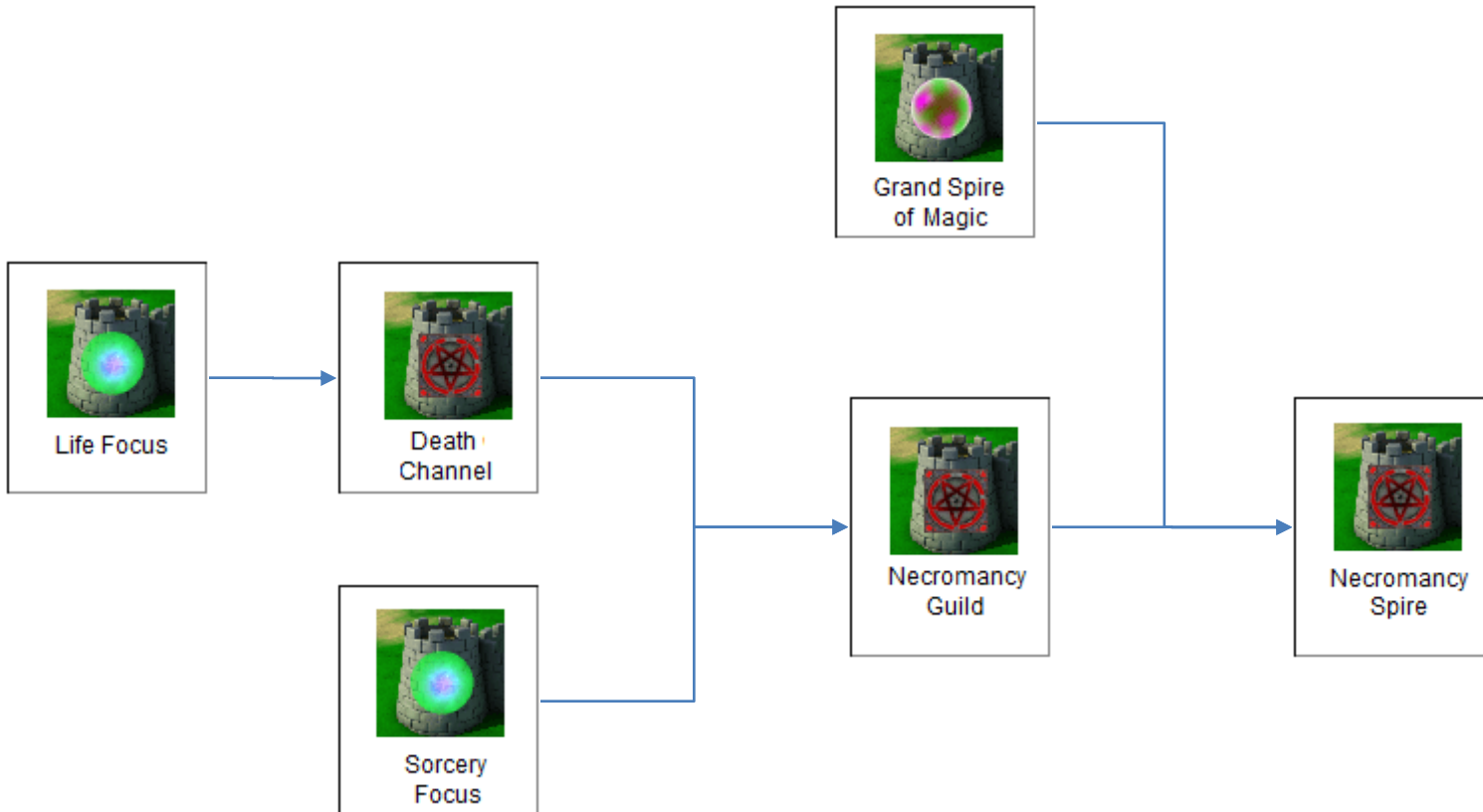

# Elementalist Path

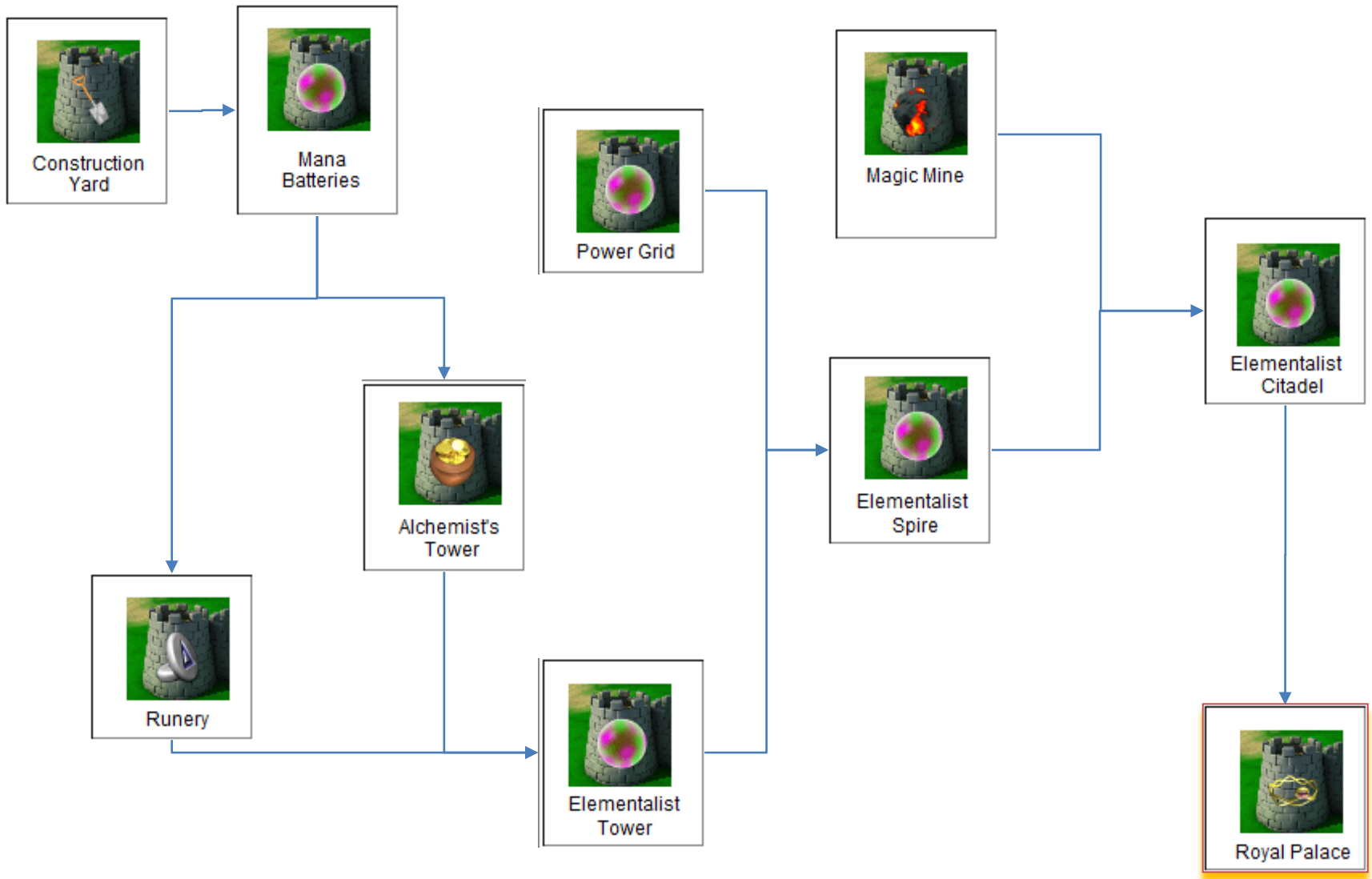

# Food Path

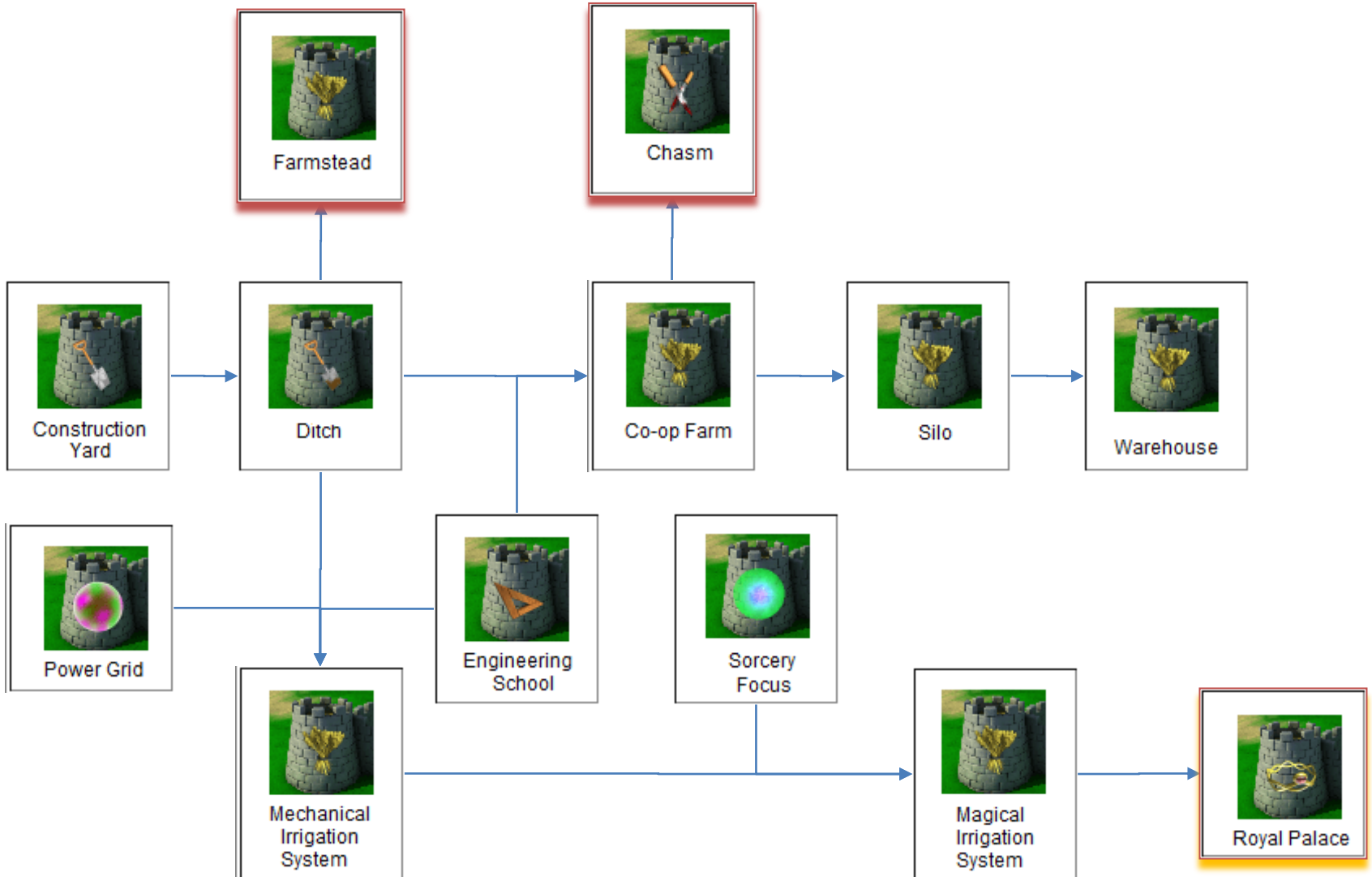

# Knowledge Path

## Main

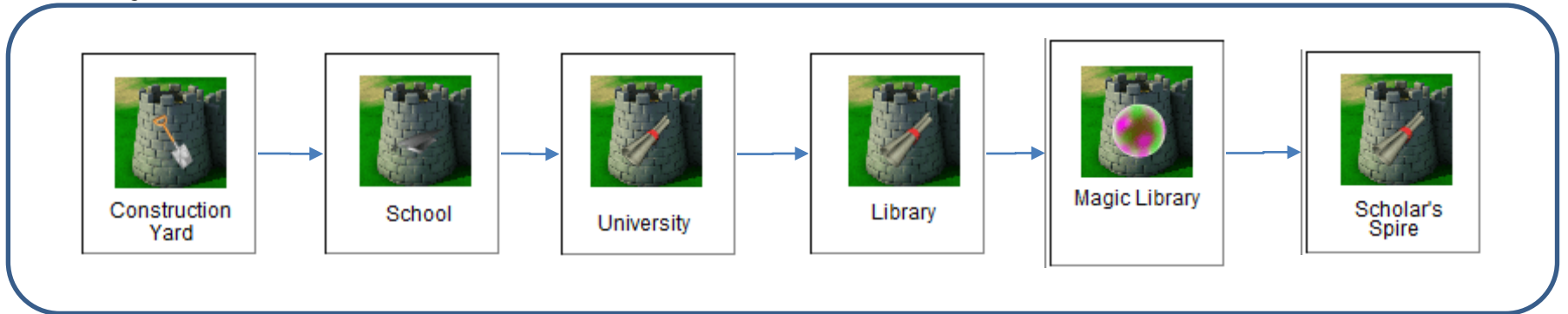

## Providing Research

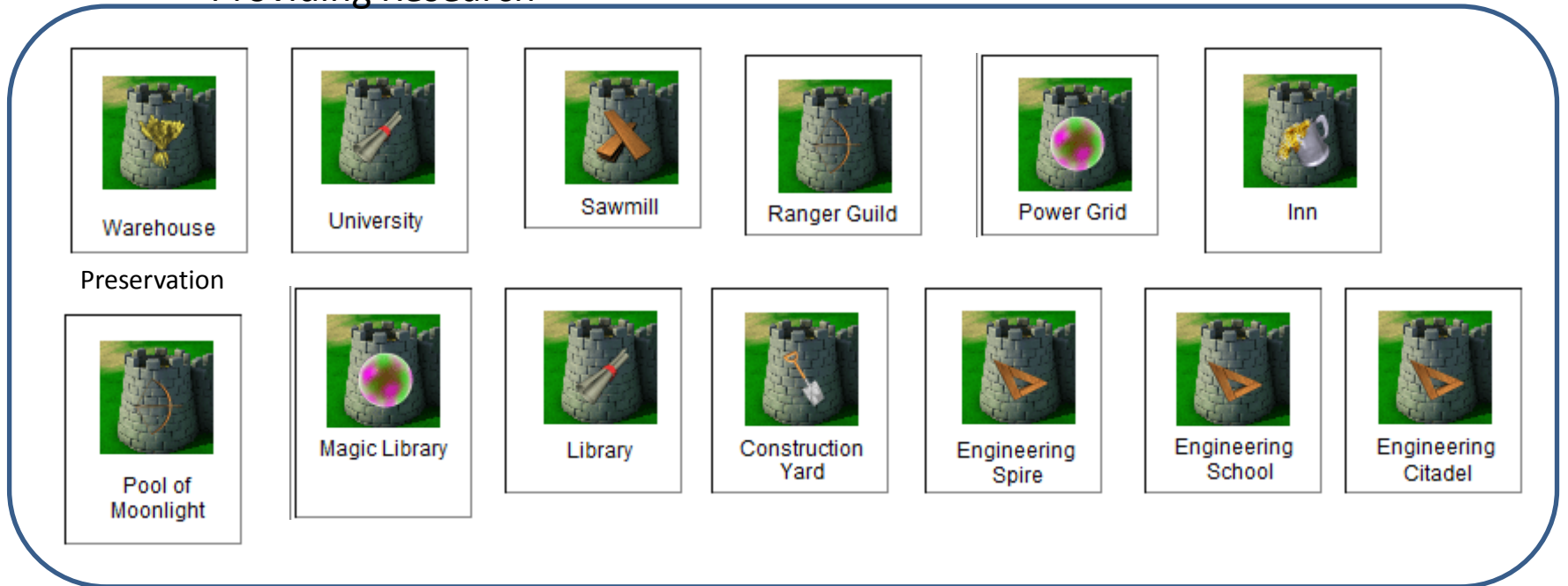

# Engineering Path

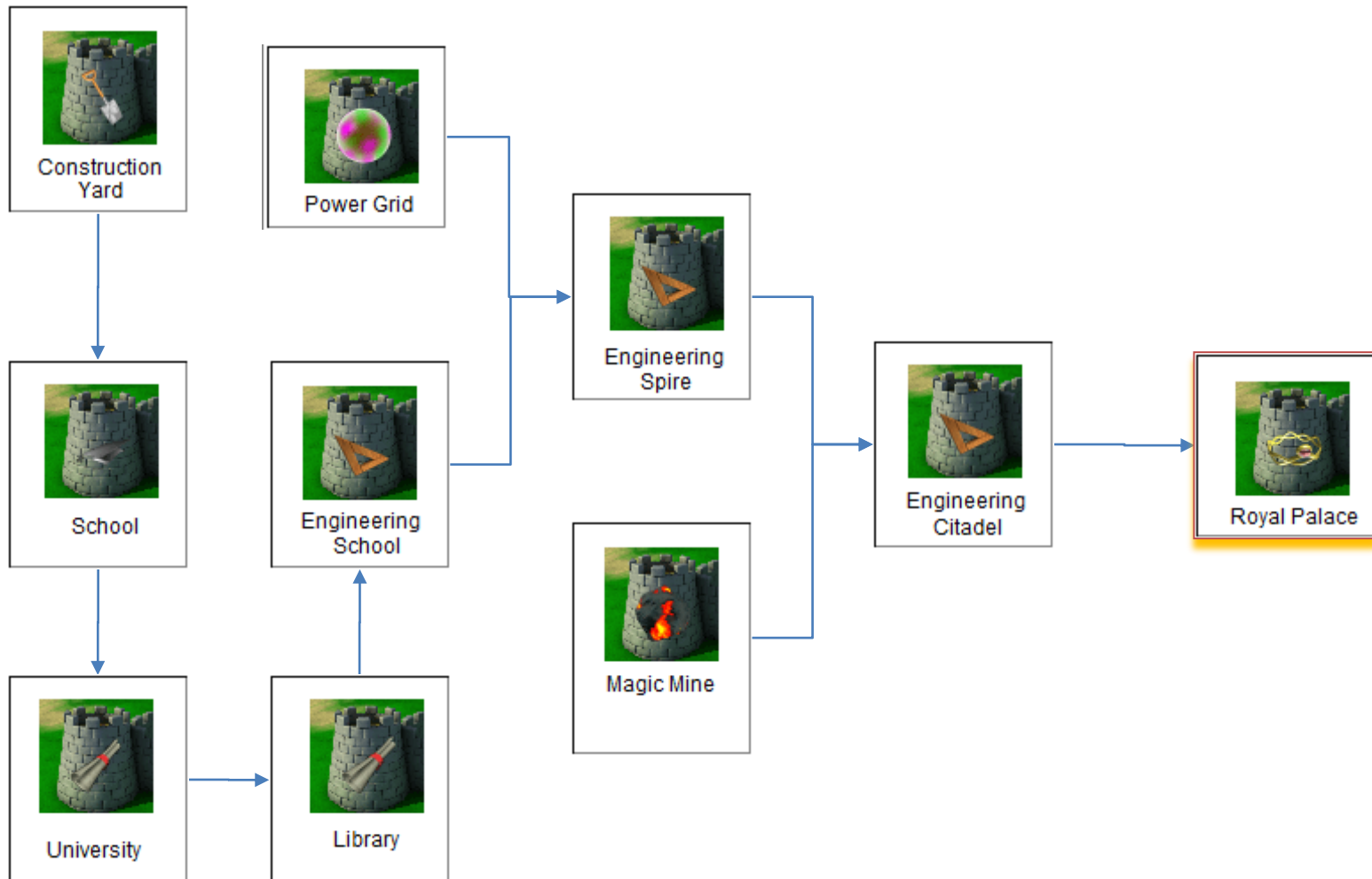

# Religion/Healer Path

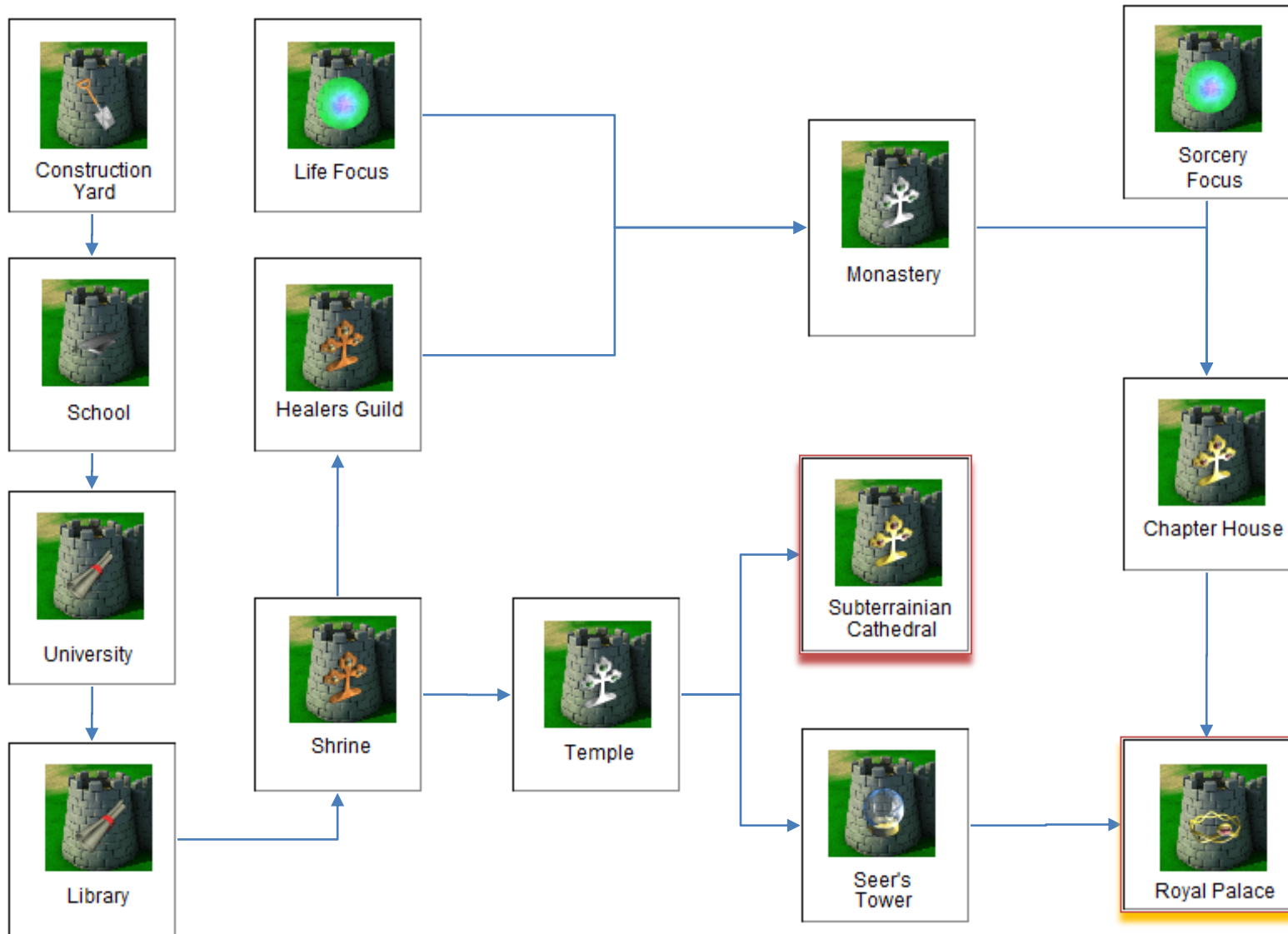



# Magic Path

Mages Must cast Magic Focus Spell from Elementalist Tower to Build Focus Buildings

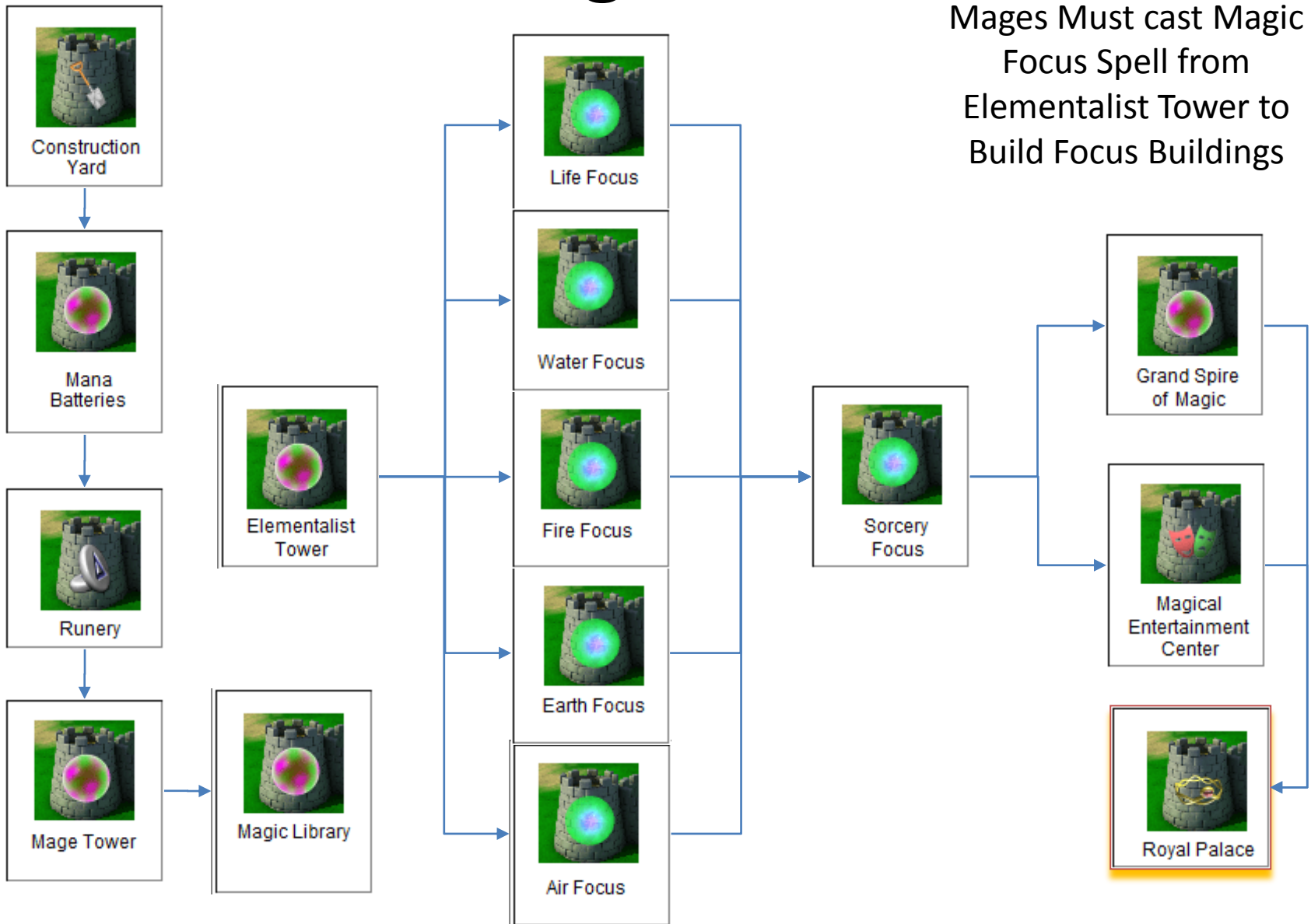



# Military Path Part 2

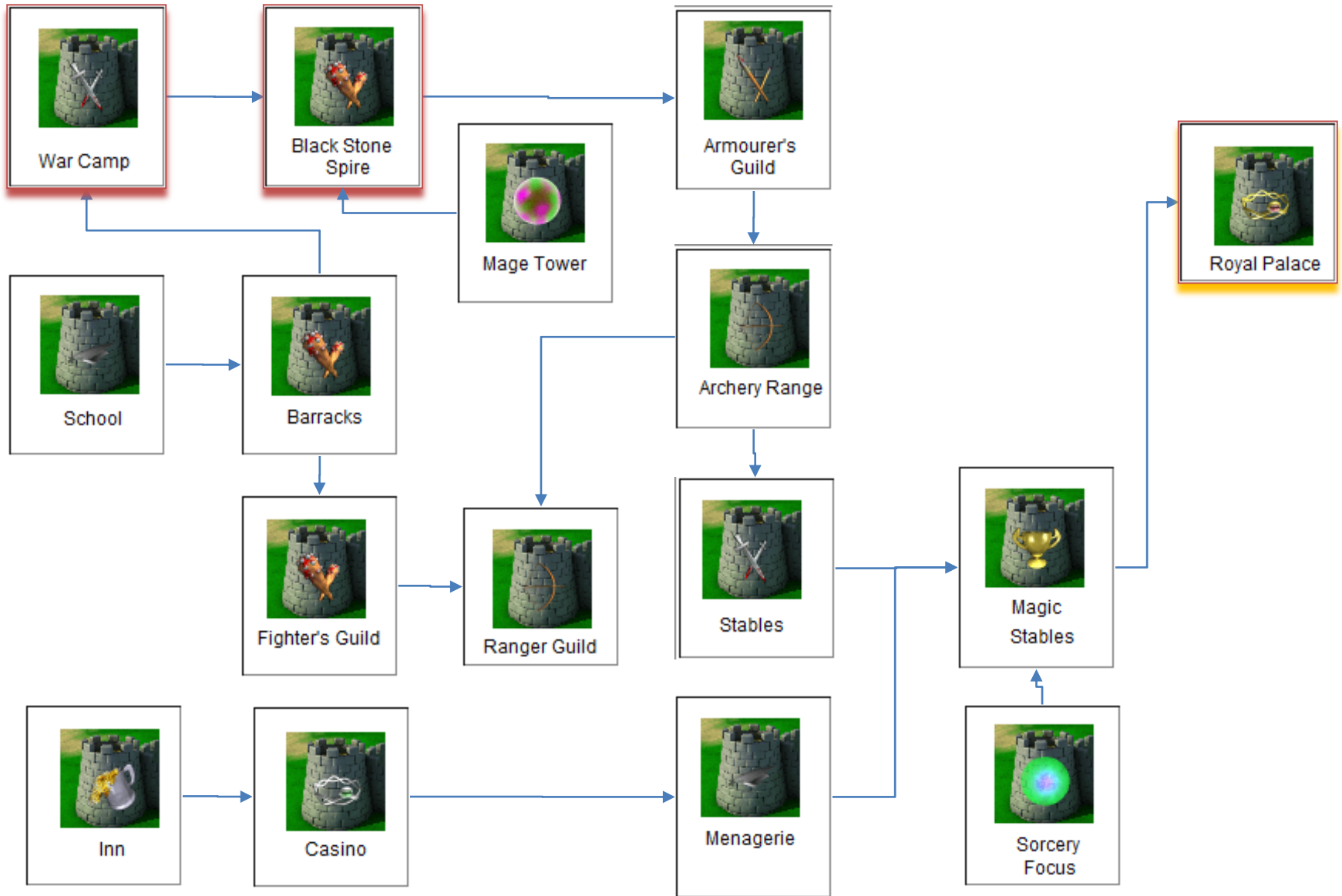

# Finance Path

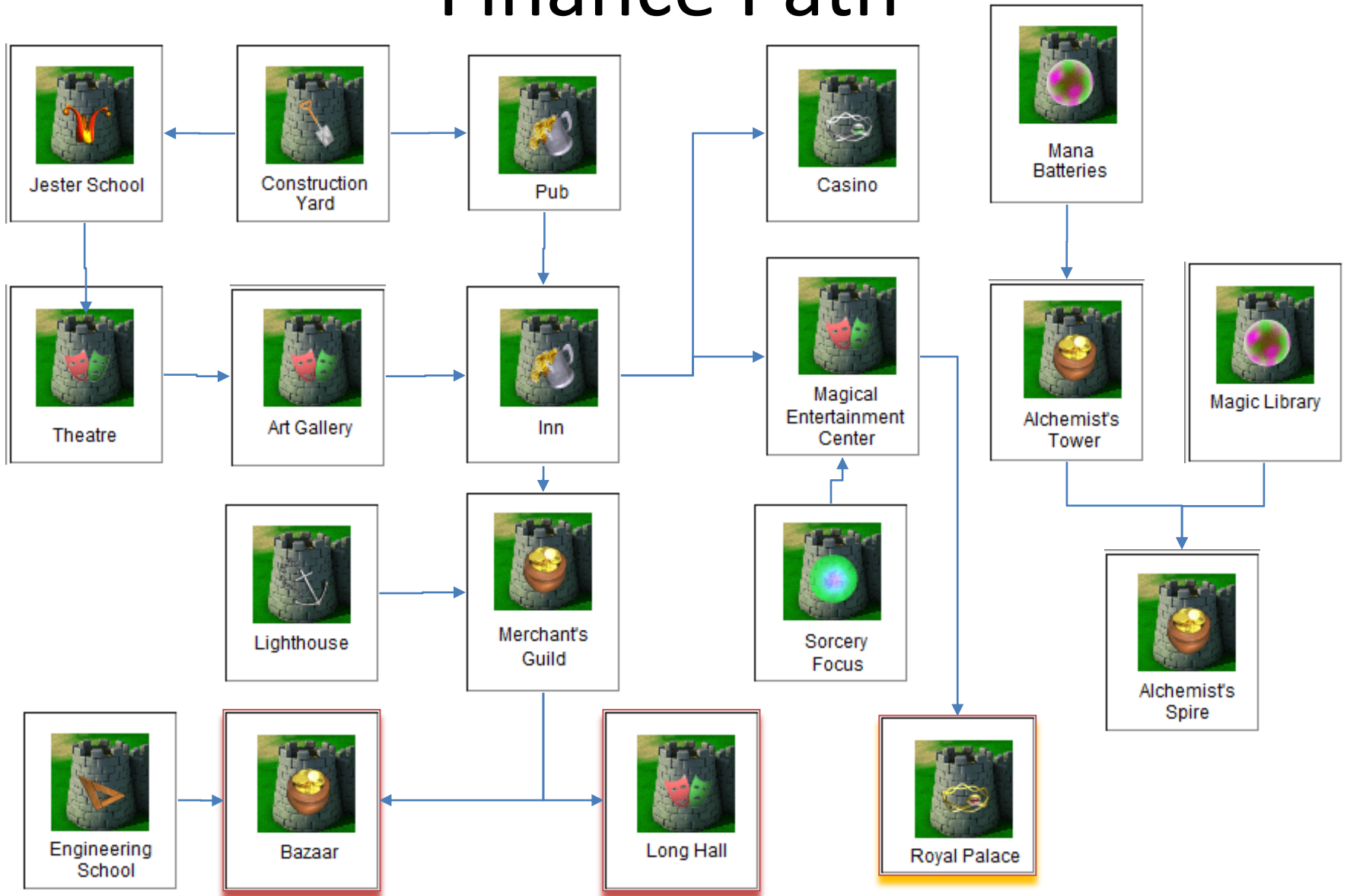

# Naval Path

